

ÉLÉVATION DES CADRES

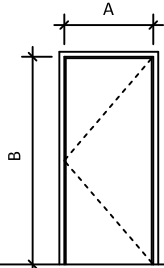

Élévation 1

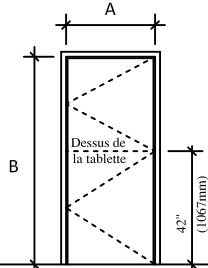

Élévation 1H

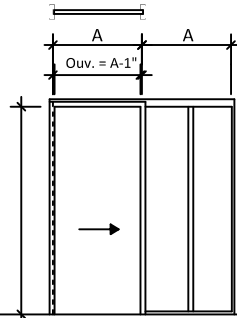

Élévation 1P

CADRE POUR PORTE ESCAMOTABLE

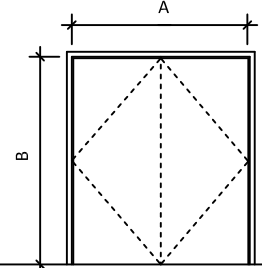

Élévation 2

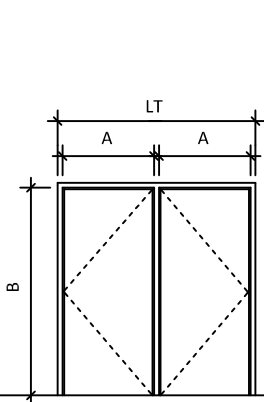

Élévation 3

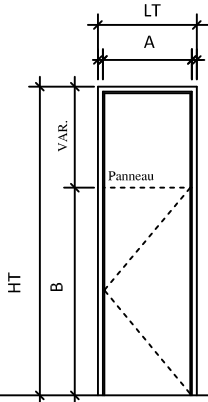

Élévation 4

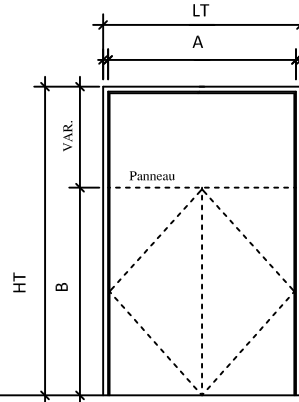

Élévation 5

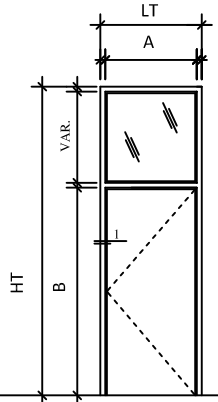

Élévation 6

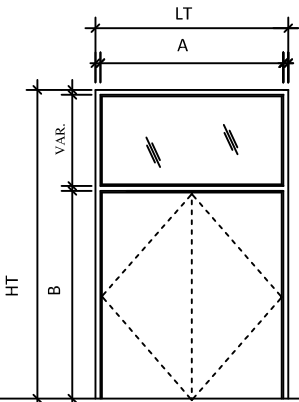

Élévation 7

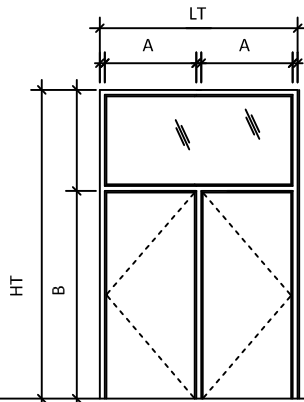

Élévation 7a

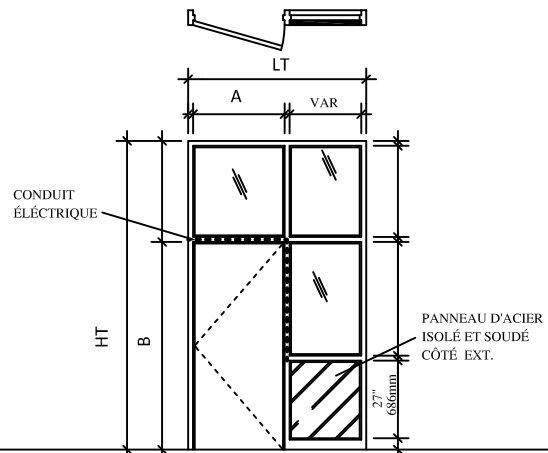

Élévation 8



INTER-PORTES INC.

3400 BOUL. LOSCH, LOCAL 46
ST-HUBERT, P.Q. J3Y 5T6

ÉLÉVATION DES CADRES

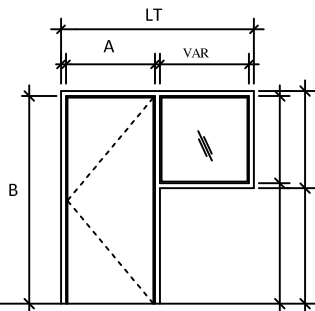

Élévation 9

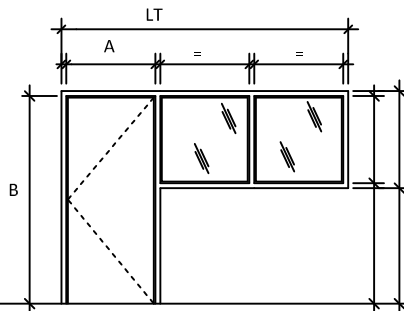

Élévation 10

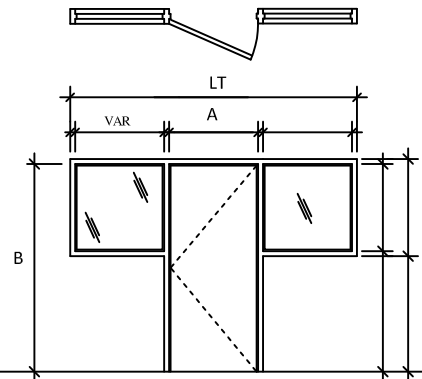

Élévation 13

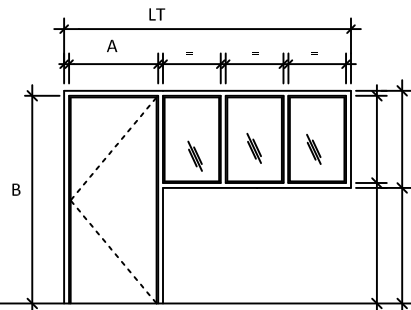

Élévation 20

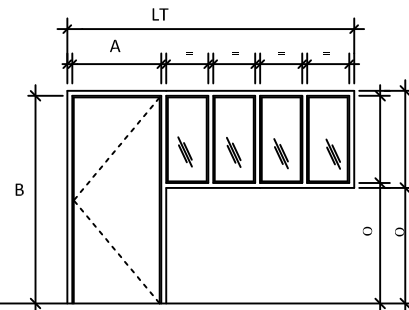

Élévation 21

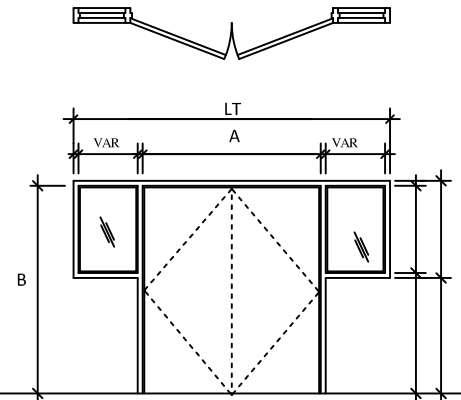

Élévation 22

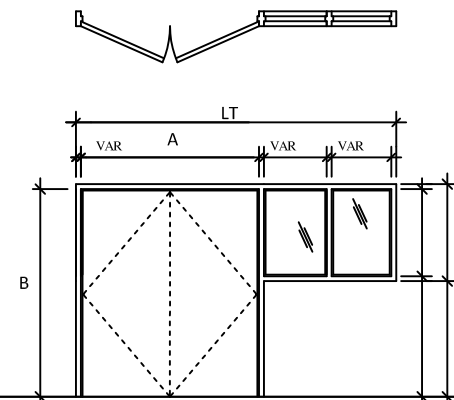

Élévation 23

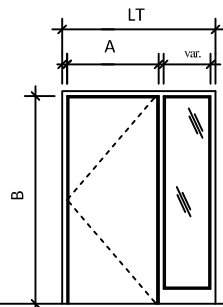

Élévation 11

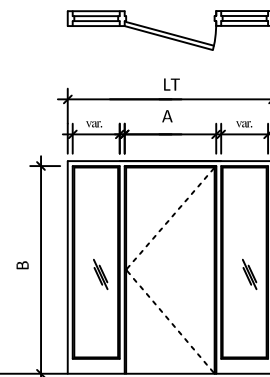

Élévation 12

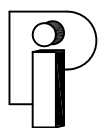

INTER-PORTES INC.

3400 BOUL. LOSCH, LOCAL 46
ST-HUBERT, P.Q. J3Y 5T6

ÉLÉVATION DES CADRES

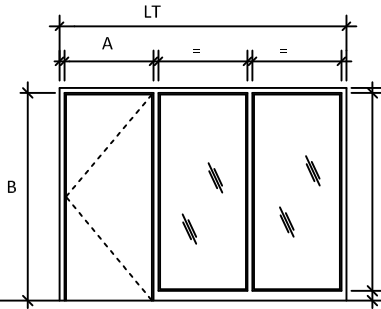
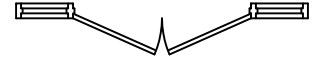

Élévation 35

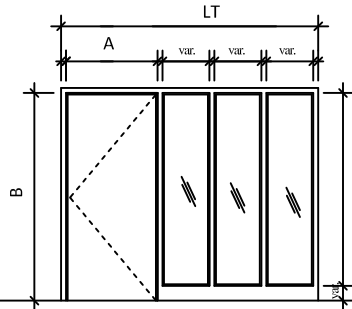

Élévation 36

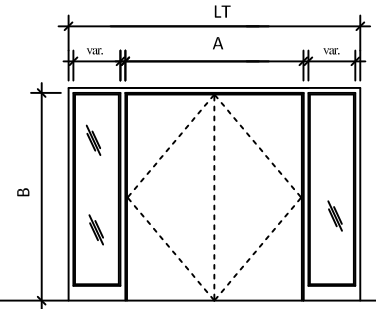

Élévation 37

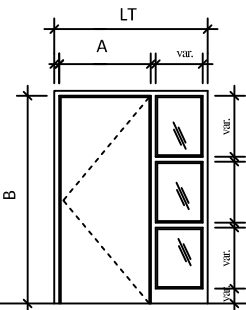
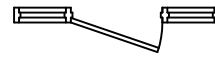

Élévation 38

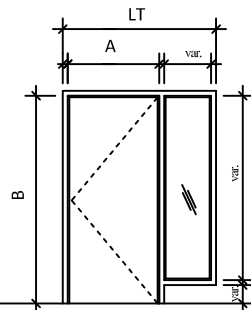

Élévation 32

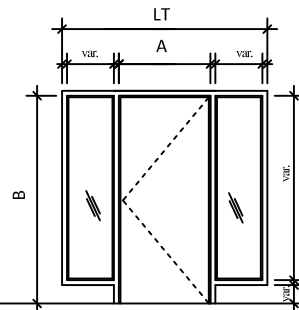

Élévation 33

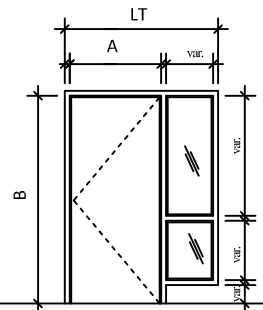

Élévation 24

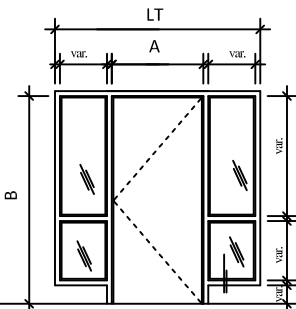
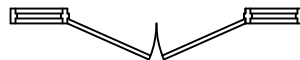
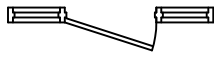

Élévation 25

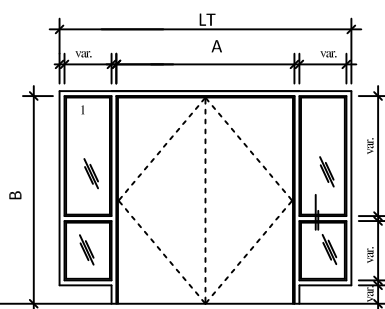

Élévation 26

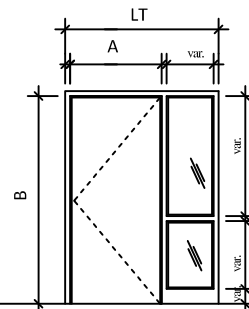

Élévation 26a

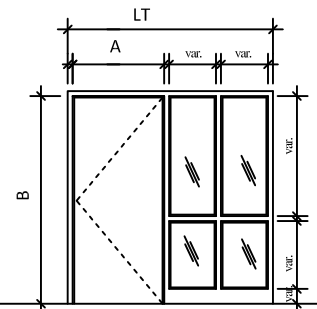

Élévation 27



INTER-PORTES INC.

3400 BOUL. LOSCH, LOCAL 46
ST-HUBERT, P.Q. J3Y 5T6

ÉLÉVATION DES CADRES

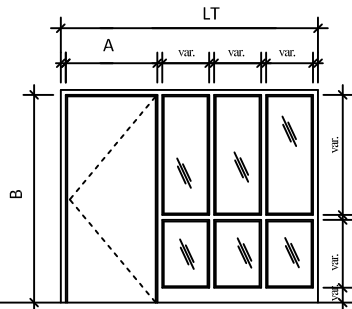

Élévation 28

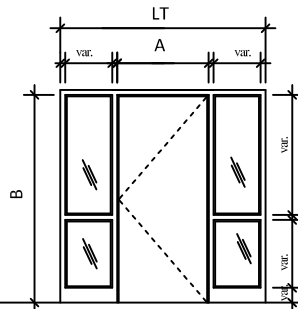

Élévation 30

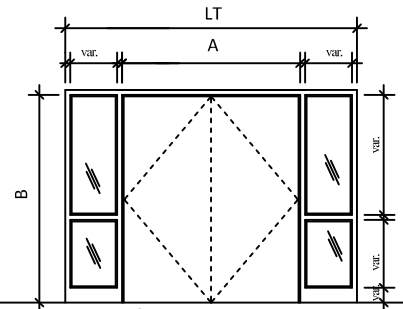

Élévation 31

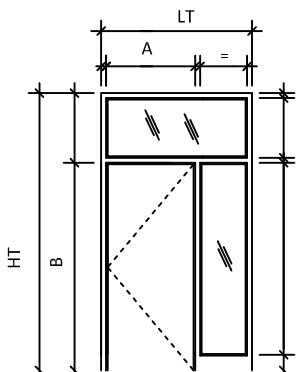

Élévation 19

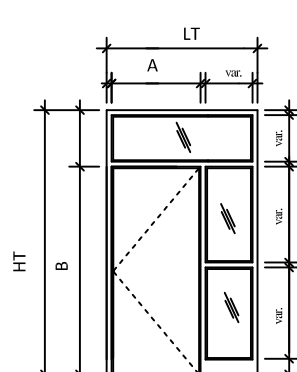

Élévation 45

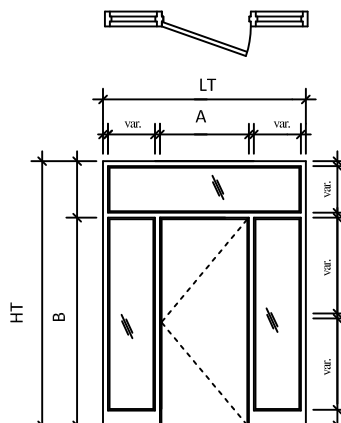

Élévation 47

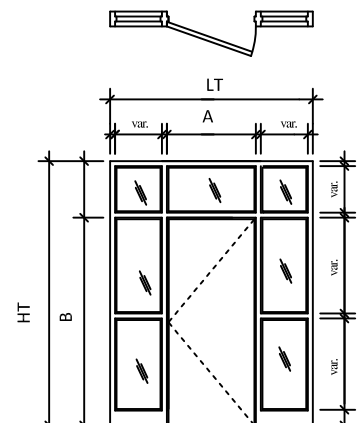

Élévation 48

NOTE: PANNEAUX DE 1^{er} AVEC MOULURE ET VERRE THERMO SONT DU CÔTÉ INTÉRIEUR DU CADRE

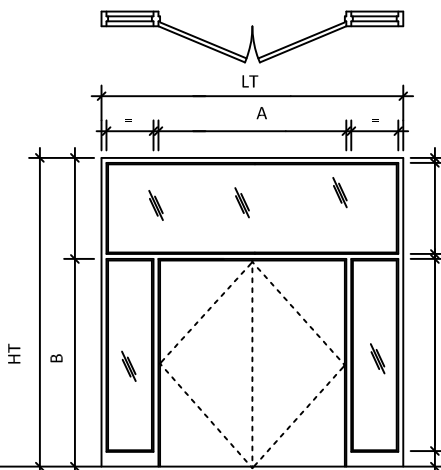

Élévation 14

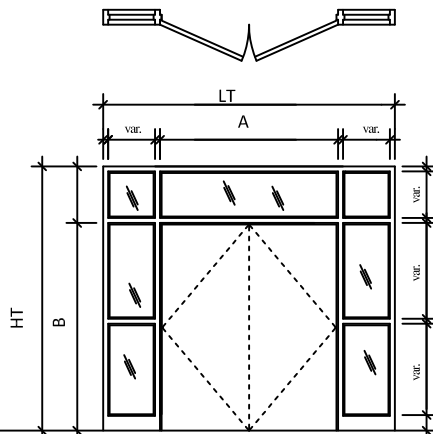

Élévation 49

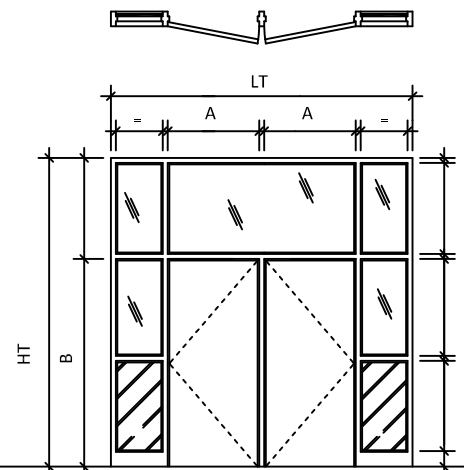

Élévation 14a

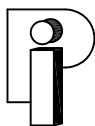

INTER-PORTES INC.

3400 BOUL. LOSCH, LOCAL 46
ST-HUBERT, P.Q. J3Y 5T6

ÉLÉVATION DES CADRES

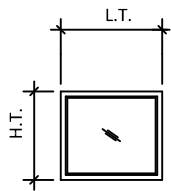

Élévation 15

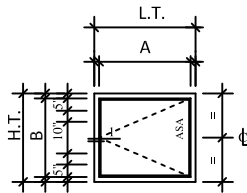

Élévation 15P

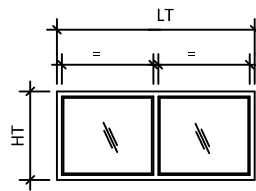

Élévation 16

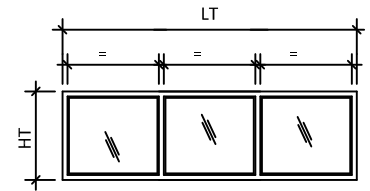

Élévation 17

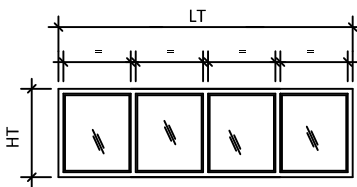

Élévation 50

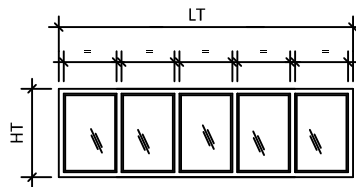

Élévation 51

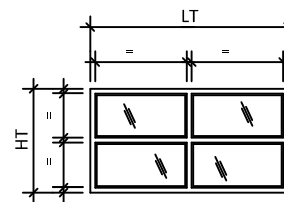

Élévation 61

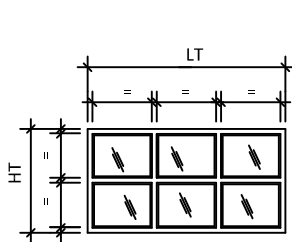

Élévation 62

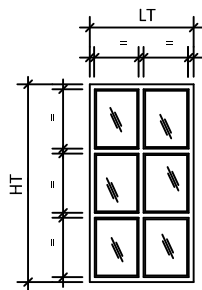

Élévation 63

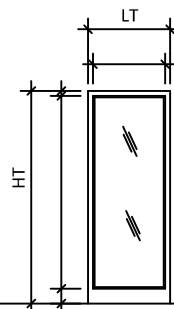

Élévation 18

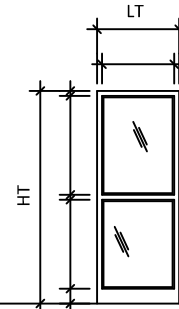

Élévation 18A

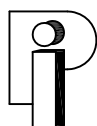

INTER-PORTES INC.

3400 BOUL. LOSCH, LOCAL 46
ST-HUBERT, P.Q. J3Y 5T6

ÉLÉVATION DES CADRES

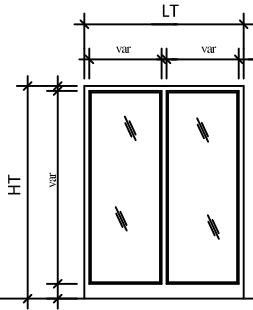

Élévation 64

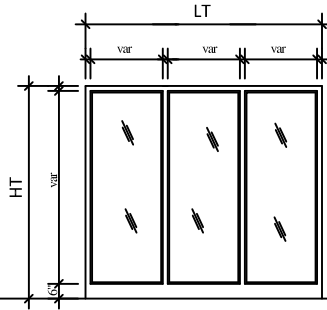

Élévation 65

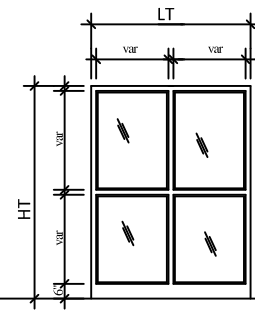

Élévation 54

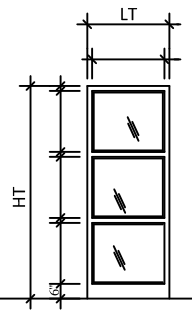

Élévation 55

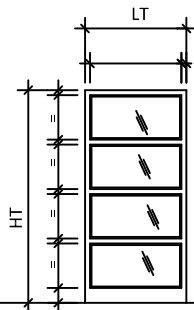

Élévation 56

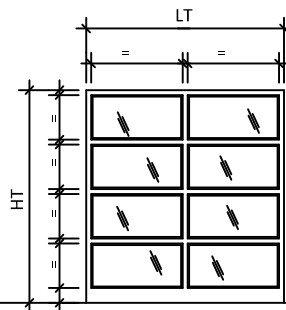

Élévation 56b

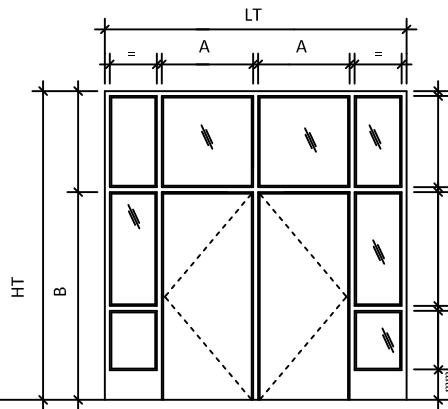
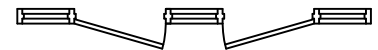
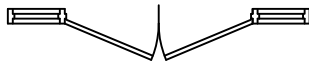

Élévation 81

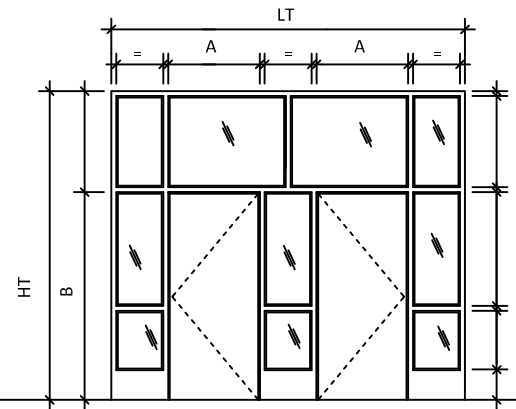

Élévation 86



INTER-PORTES INC.

3400 BOUL. LOSCH, LOCAL 46
ST-HUBERT, P.Q. J3Y 5T6